

ROD FLOOR 120

SINGLE-RAIL BARRIER

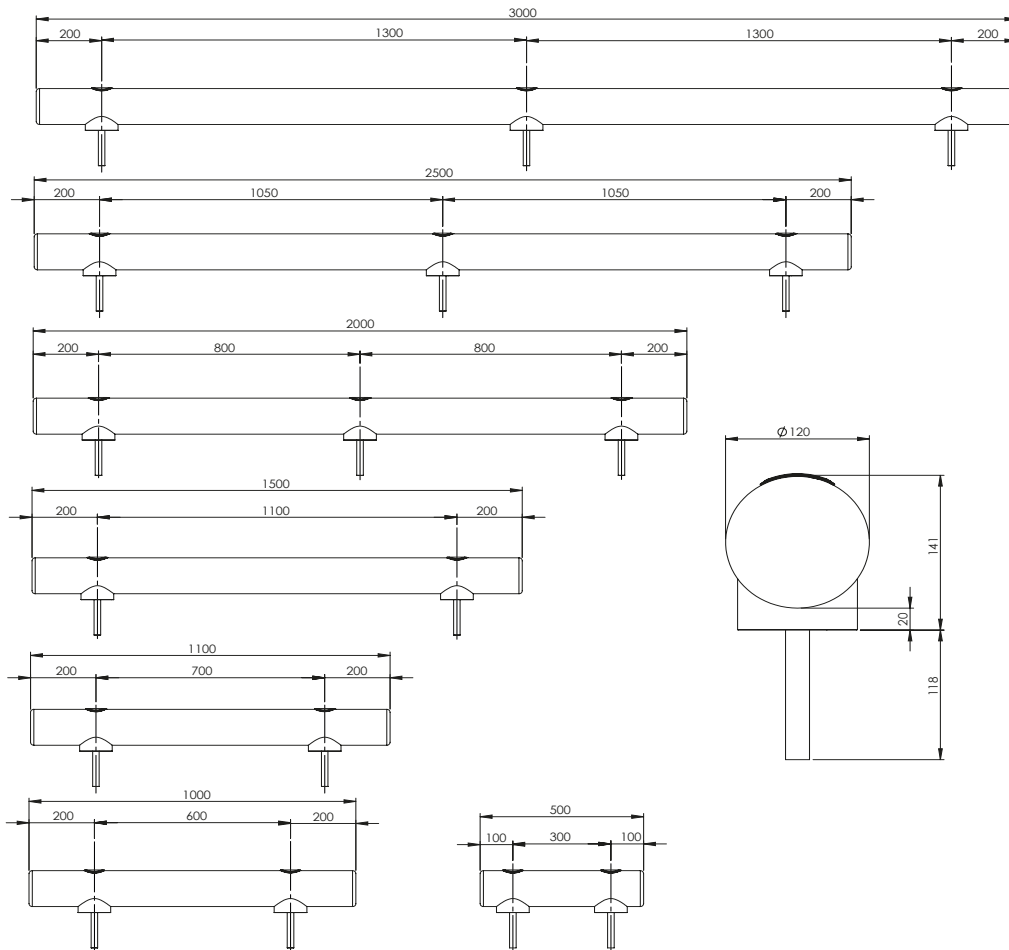

RESISTANT TO
LOW TEMPERATURES

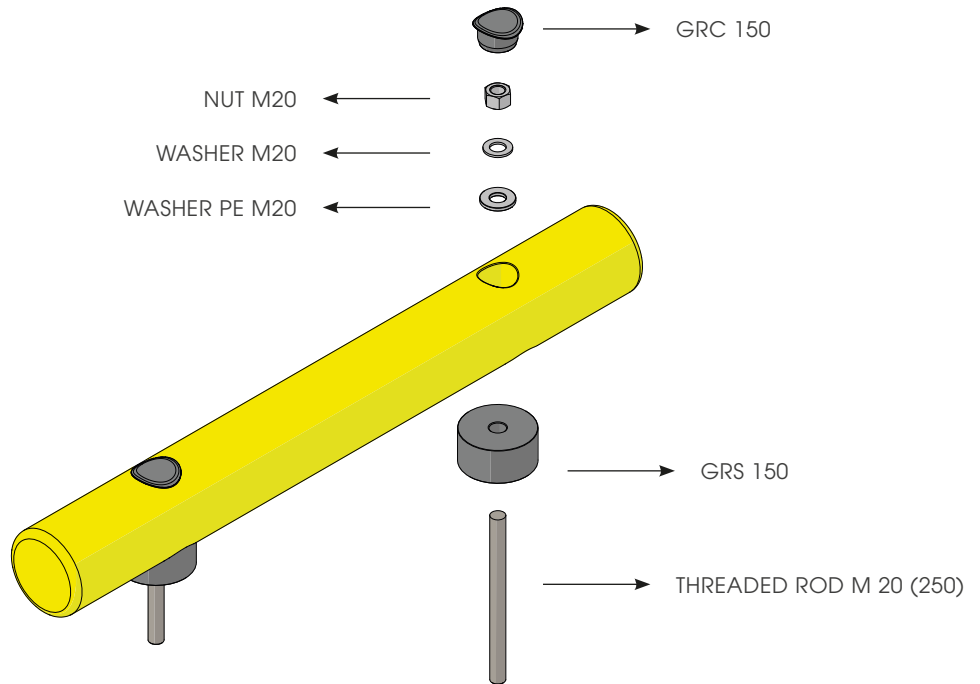

ROD FLOOR 120

ASSEMBLY INSTRUCTIONS

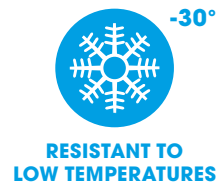

ONLY WITH RESIN

CHEMICAL ANCHOR

Ø24 mm

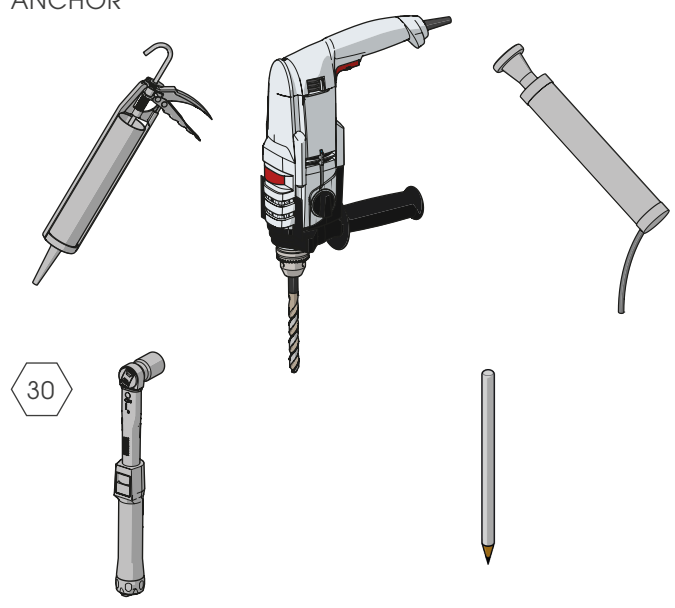

30

1

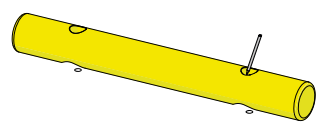

2

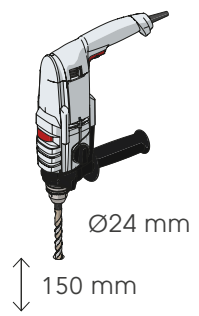

3

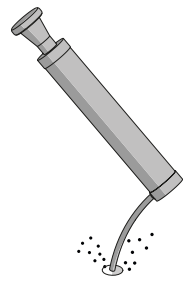

4

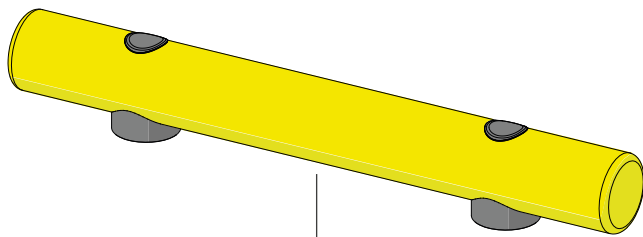
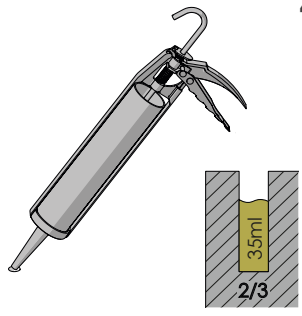

WARNING
The distance of installation depends on speed and weight of vehicle

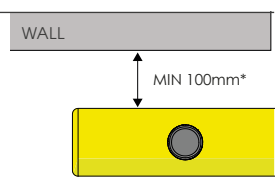

ROD FLOOR 120

ASSEMBLY INSTRUCTIONS

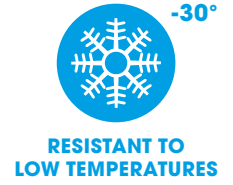

ONLY WITH RESIN

