

PED 90

SAFETY BARRIER

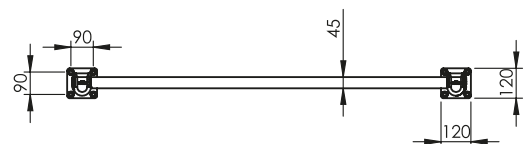
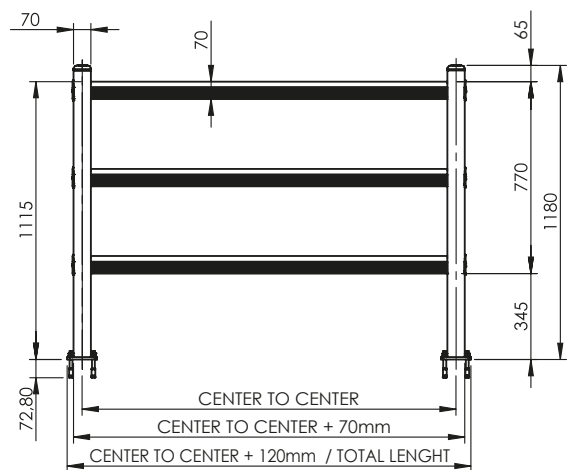
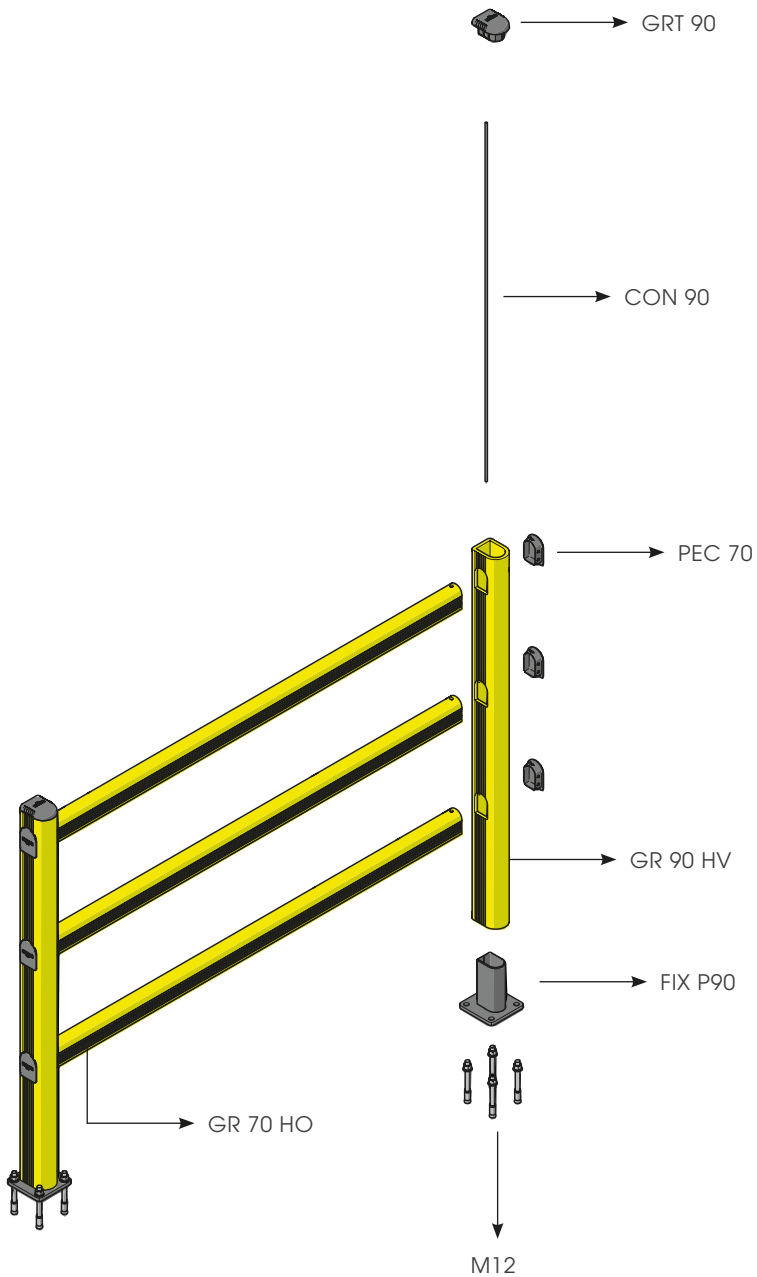

PED 90

ASSEMBLY INSTRUCTIONS

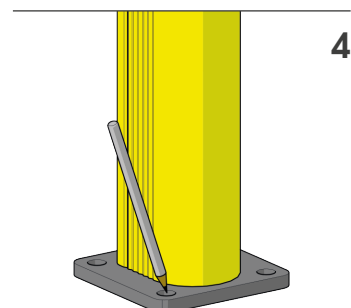
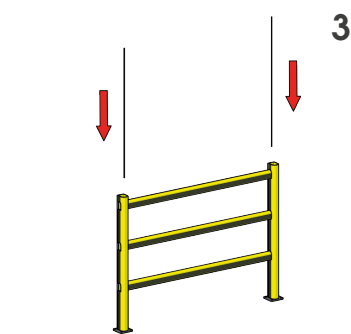
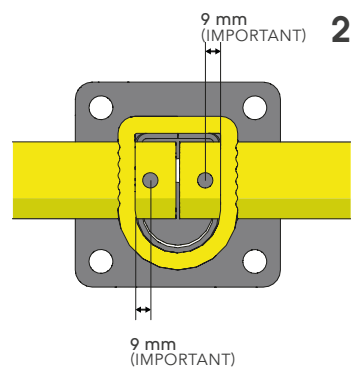
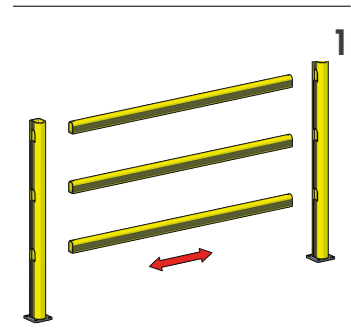
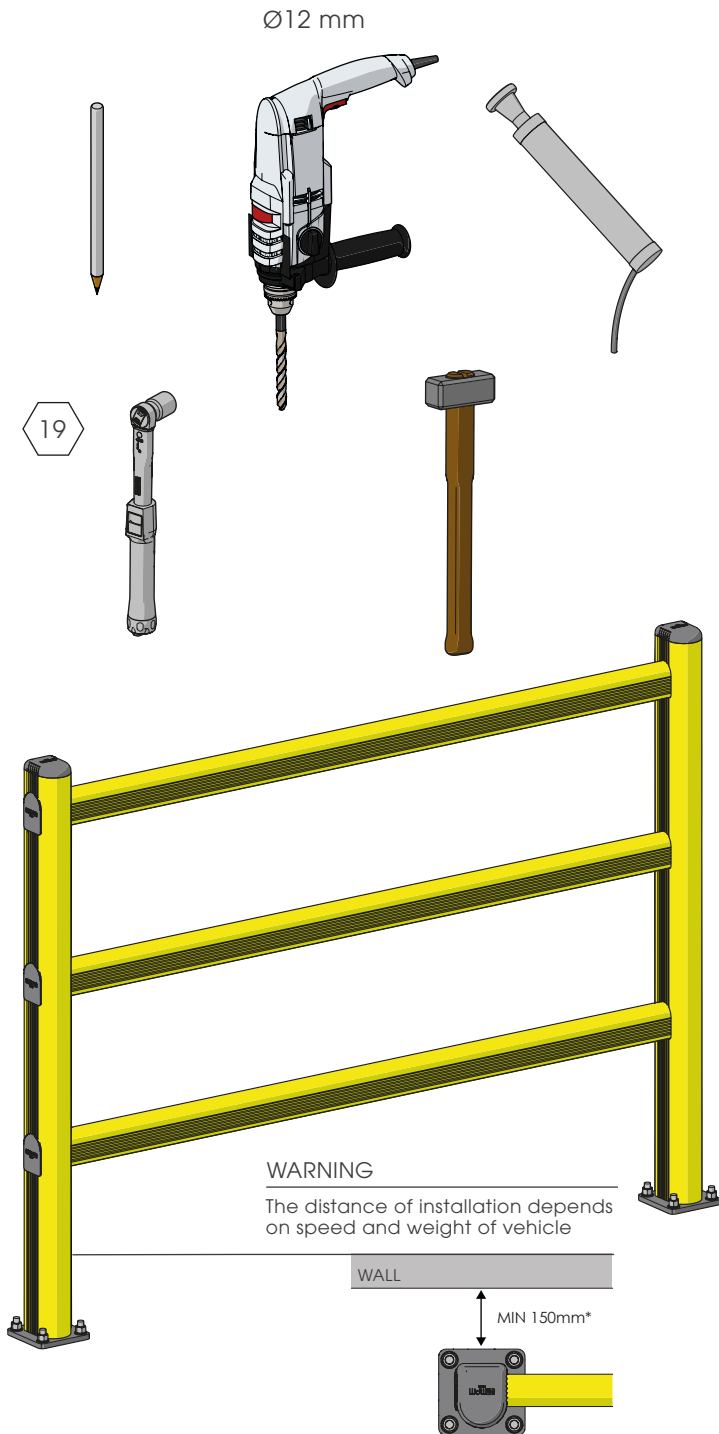

PED 90

ASSEMBLY INSTRUCTIONS

