

# PED 150 PIN

SAFETY BARRIER

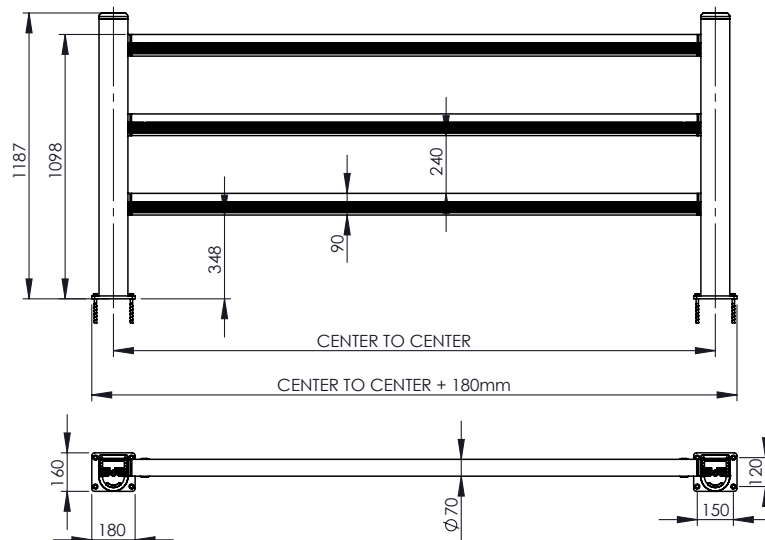
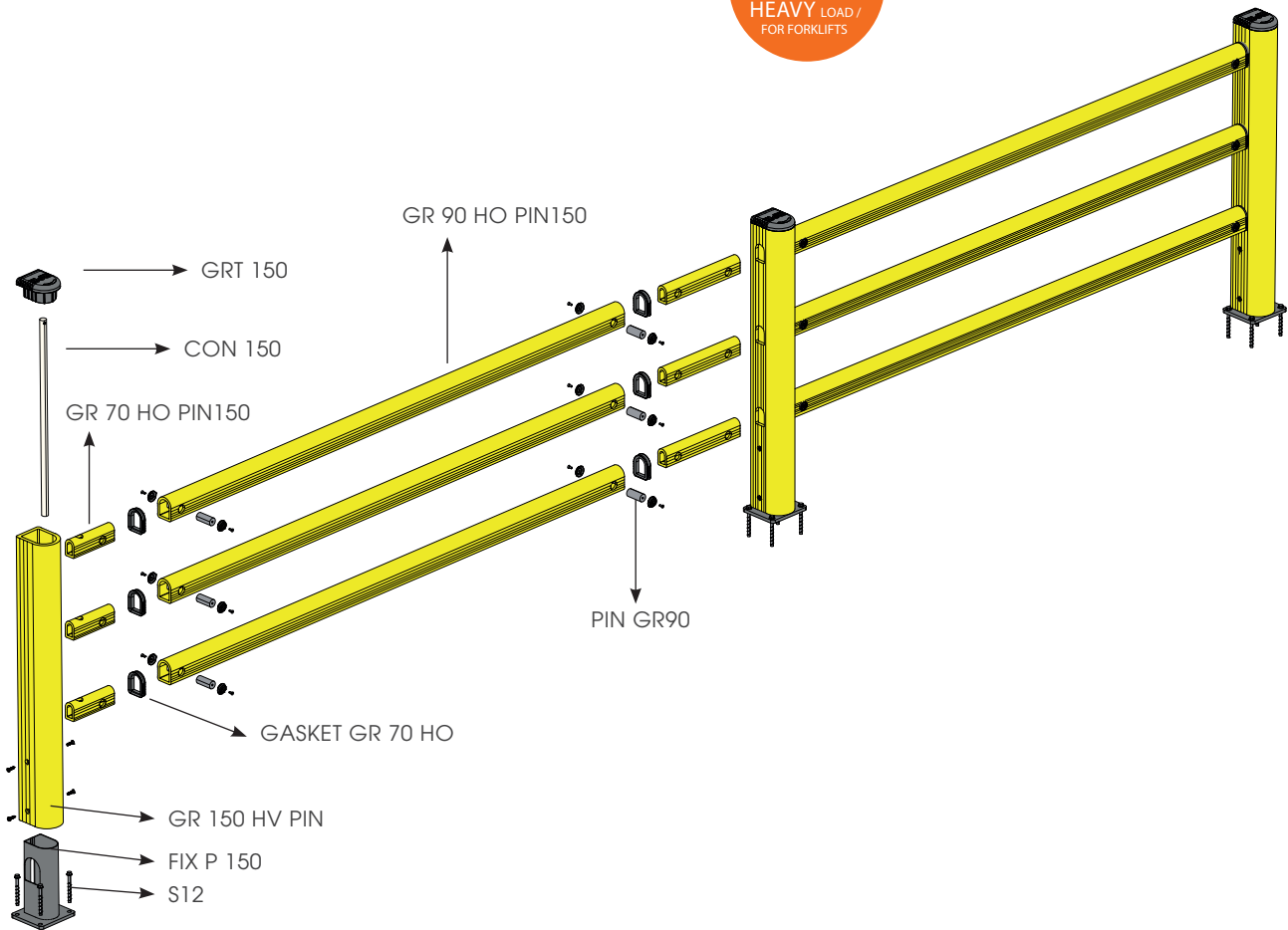

# PED 150 PIN

## ASSEMBLY INSTRUCTIONS



### WARNING

The distance of installation depends on speed and weight of vehicle

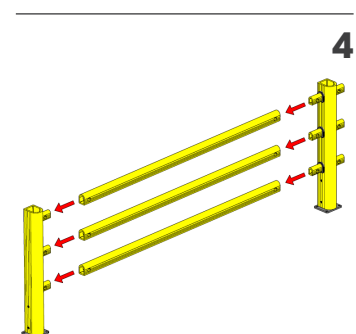
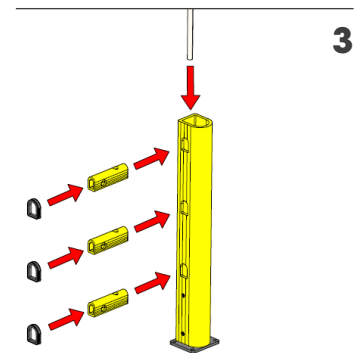
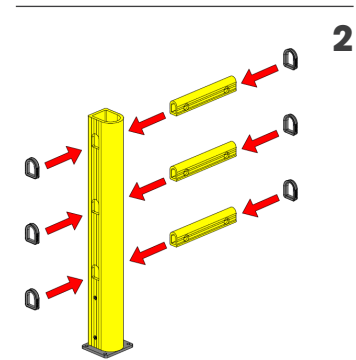
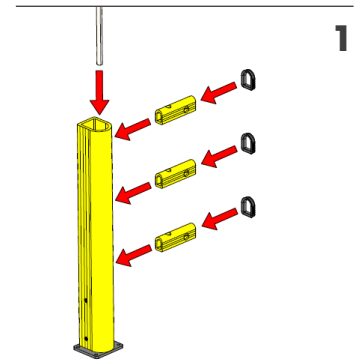
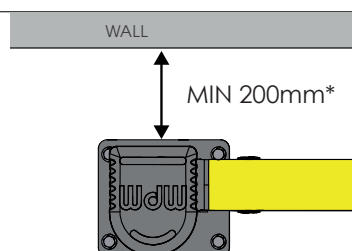

# PED 150 PIN

## ASSEMBLY INSTRUCTIONS

